

Principal.



KITCHEN RANGE CATALOGUE

It's your decision

The very best kitchen solutions from around the world have been brought together to create a stunning range of modular kitchens, all available to order today.

Durability is key across the entire Principal range with doors and drawer fronts in quality laminate, UV, acrylic, 2 pack painted finishes, special order personal colours, cabinets built in Australia, German soft close drawers and Italian soft close hinges. The care and attention to detail we put into every kitchen makes a world of difference.

The Principal quality

Every detail of the kitchen you're about to discover has been designed around the very best in contemporary living. With clever storage solutions, the latest finishes and special touches to make your kitchen distinctly your own, Principal helps set a new standard in kitchen design trends. Discover durable and stylish benchtops and finish your room with sinks and tapware. From traditional looks to ultra cool and contemporary, there really is something to inspire everyone in a Principal kitchen.

Installing your Principal kitchen couldn't be easier with all assembly hardware included in our cabinet packs such as hinges, soft close runners, screws and cabinet feet. No separate purchases of this hardware or fasteners are required.

Finest quality finishes

Our kitchens are finished with the finest quality doors and drawer fronts in Melamine, UV, acrylic and 2 pack painted finishes, Italian soft close hinges, soft close drawer runners and hardware from Häfele and Kesseböhmer. For the ultimate peace of mind, all of these components come with a 10 year guarantee.

Premium 18mm doors

Quality and durability is key. Substantial 18mm doors on all our kitchens provide that premium feel and reduce the risk of bowing.

With you all the way

Our in store designers are on hand to help you select the right kitchen for your home and your lifestyle. And they know every detail of the kitchens inside and out, to give you the right advice first time, every time.

Available to order and ready when you are

Subject to availability, your kitchen will usually be ready to deliver in as little as 14 days.

Our warranty - built for life

Your kitchen is the heart to the home. So it's great to know your Principal kitchen is backed by a 10 year guarantee. All cabinetry features solid backs, moisture resistant E1 Australian particle board, quality polymer edging on all exposed edges of the cabinetry and multiple support rails to take substantial weight. Which means you can be sure your kitchen will withstand the realities of modern life.

The Environment

Principal kitchens are committed to the environment and reducing the impact we're all having on the world's natural resources. With that in mind, we created a very high set of environmental standards for our kitchens.

- > All cabinetry and doors are made using board supplied from controlled sources.
- > We use E1 (low formaldehyde emitting) rated timber board and panels in the manufacturing of all cabinets, doors and laminate benchtops.

Contents

04 PLANNING	36 SHOWCASE DOORS	62 BASE STORAGE
PRINCIPAL DOORS 06	VISTA DOORS 38	CORNER SOLUTIONS 63
08 METRO	40 LAUNDRY	64 OVERHEAD STORAGE
ALFRESCO 10	DESIRE PAINTED DOOR 42	DRAW ORGANISATION 65
12 BRIGHTON	44 OUTDOOR KITCHEN	66 WASTE & LAUNDRY MANAGEMENT
MISSION BEACH 14	CABINETRY 46	ACCESSORIES 68
16 FUJI WHITE	48 LAMINATE BENCHTOP	69 LIGHTING
JAPANESE PEAR 18	STANDARD HANDLES 50	PLANNING TIPS 70
20 PURITY	51 PREMIUM HANDLES	71 END PANELS & CAVITIES
SHAKER 22	MILANO APPLIANCES 52	MEASURING TIPS 72
24 HAMPTON	54 ALUSION SPLASHBACK	73 DESIGN SPACE
NEWPORT 26	HÄFELE SINKS 56	DELIVERY & INSTALL 74
28 SORRENTO	58 HÄFELE TAPWARE	75 ESSENTIALS CHECKLIST
BEAUMARIS 30	FILTRATION 59	6 CABINET DESIGN 76
32 KIRRA	60 PANTRY SOLUTIONS	77 ZIP MONEY
ALLURE DOORS 34		WARRANTY INFORMATION 78

Planning

Are you ready to plan your new kitchen?

Visit principal.2020.net today to start designing. Measure your space and plan your new kitchen using our online kitchen designer. Create your room, choose kitchen style, drop and drag kitchen elements - once its complete, you can share your design with friends or print it out as a shopping list to take into your local store to order.

A new kitchen doesn't have to be hard work, this helpful planning guide is full of tips and advice to help you create your dream kitchen. First up, you need to think about the basics. What do you need from your kitchen?

This is probably the most important question, because apart from looking great it really needs to function well.

Think about these things and make a list:

- > How will your family use it?
- > Do you need more storage than you have now?
- > Do you need more drawers or places to store pots and pans?
- > Will you need space for a dishwasher?
- > Is a pantry an option?



The working triangle:

Consider the natural flow between work zones in the kitchen. This work path is often referred to as the 'working triangle'. The working triangle illustrates the path between the most frequently used work areas, such as the fridge, sink and cooking appliances. Reducing the size of the working triangle will save you time and effort in your new kitchen. Using these four common kitchen layouts (Straight line, L-shape, U-shape and Galley), and referring to the working triangle, select the design most suited to your new kitchen.

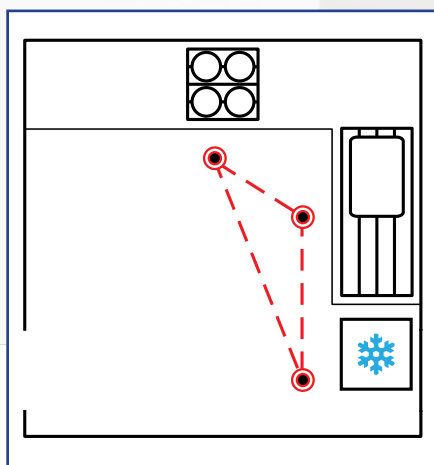

L-SHAPED KITCHEN

One of the most common layouts is the L-shaped kitchen, ideal for homes incorporating a small table for dining in the kitchen space.



 = Fridge  = Cooktop  = Sink

Principal.

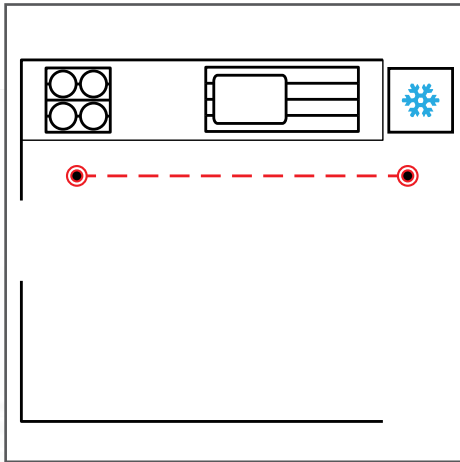

STRAIGHT LINE KITCHEN

This layout is best when the space available for your new kitchen is limited. There is no working triangle shown because the workflow is based on a straight line.

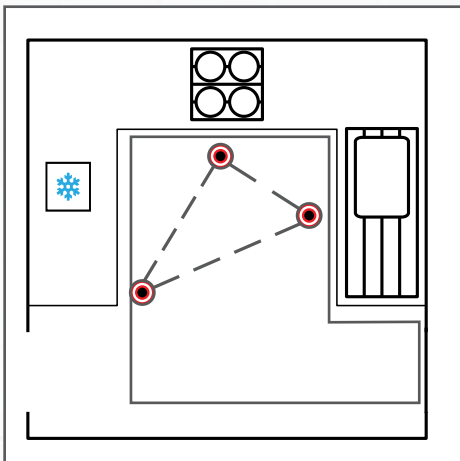

U-SHAPED KITCHEN

If you have a large room, and want the most efficient working triangle, then the U-shaped kitchen is ideal. It is also perfect for the demands of a family, offering maximum storage space with many wall cabinet options.

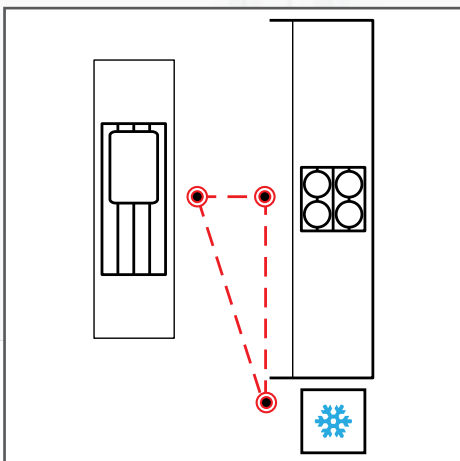

GALLEY KITCHEN

This layout is featured in many homes, as it provides two opposing working and storage areas. Add a couple of bar stools to the island unit and this becomes a great kitchen for entertaining. Ideal for open plan living.



Principal.

PRINCIPAL DOORS

The Principal range features 18mm doors as standard and are manufactured using only sustainable timber sources.

Quality and durability is key across the entire Principal range. Offering doors and drawer fronts in laminate, UV, acrylic and 2 pack painted finishes. The substantial 18mm doors provide that premium feel and reduce the risk of bowing



Principal.



METRO PAGE 8
White Matt
Premium Melamine



ALFRESCO PAGE 10
Woodgrain Matt
Premium Melamine



BRIGHTON PAGE 12
Light Grey Gloss
UV Lacquer

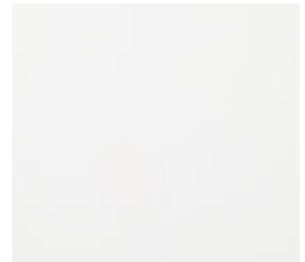

MISSION BEACH PAGE 14
White Gloss
UV Lacquer



SORRENTO PAGE 28
Dark Grey Gloss
UV Lacquer



JAPANESE PEAR PAGE 18
Woodgrain Gloss
UV Lacquer



PURITY PAGE 20
White Gloss
2 pack paint



SHAKER PAGE 22
White Satin
2 pack paint



HAMPTON PAGE 24
White Gloss
2 pack paint



NEWPORT PAGE 26
White Gloss
2 pack paint



FUJI WHITE PAGE 16
White Gloss
Acrylic



BEAUMARIS PAGE 30
Grey Metallic Gloss
Acrylic



KIRRA PAGE 32
White satin
2 pack paint



ALLURE PAGE 34
Frosted Glass
Aluminium Frame



SHOWCASE PAGE 36
White Gloss, Clear Glass
2 pack paint



VISTA PAGE 38
White Satin, Clear Glass
2 pack paint

Principal.

METRO

Classic, timeless and clean lines. Metro white doors work perfectly in any kitchen. This sleek, straight line design is perfect for a studio space. The clean, simple lines hide a myriad of features like plate drawers with a smooth soft close motion. All at a price that will amaze you.



METRO
White Matt
Premium Melamine



Principal.



Benchtops, splashback, handles, sinks, taps, appliances and accessories are available as optional extras

Principal.

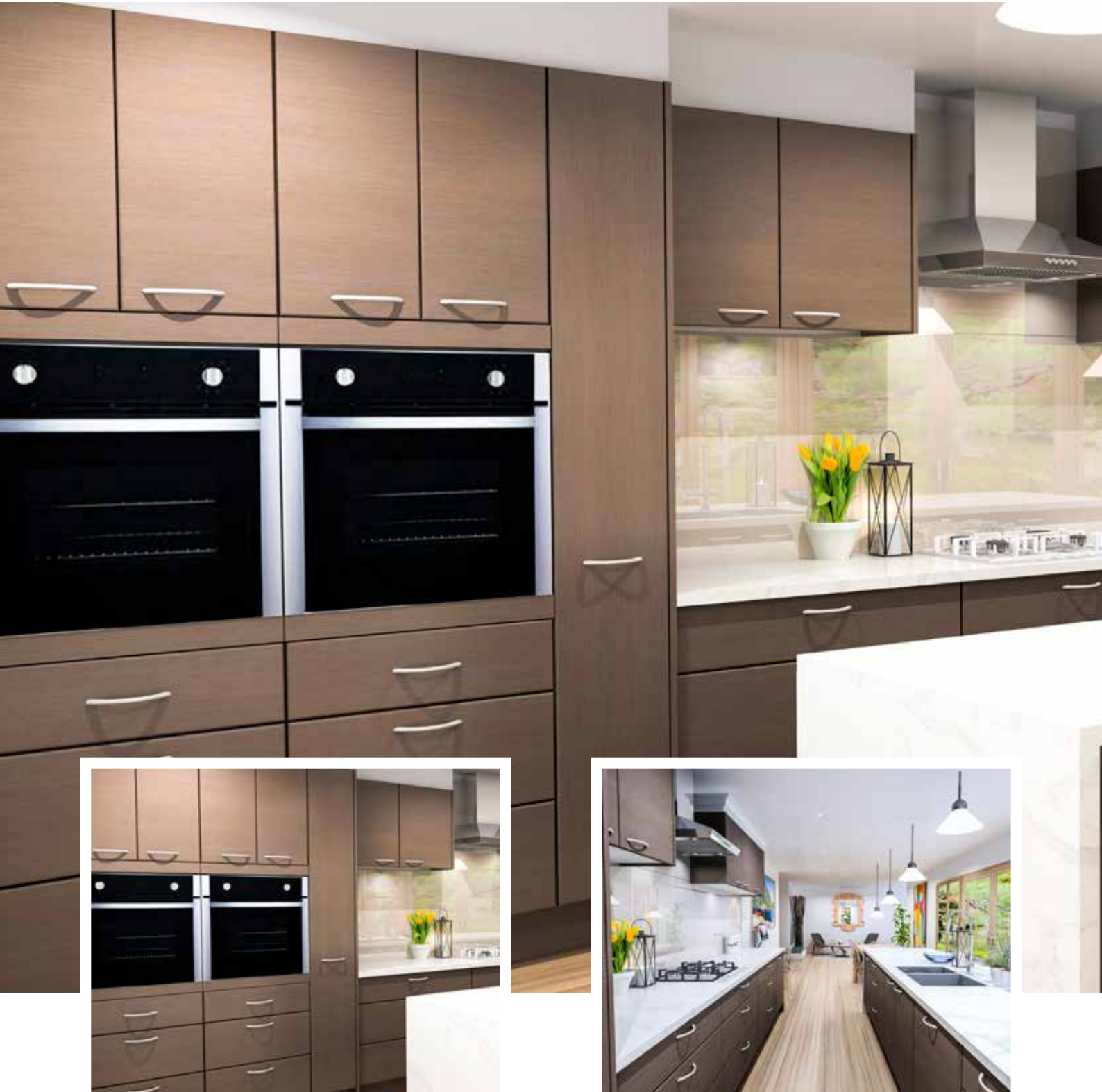

Benchtops, splashback, handles, sinks, taps, appliances and accessories are available as optional extras

Principal.

ALFRESCO

Alfresco provides a modern fine grain timber look. This impressive galley style design with a contemporary colour scheme and bold accents is a classic example of a kitchen you would normally find in a designer apartment or home all with a smooth soft close action.



ALFRESCO
Woodgrain Matt
Premium Melamine

Principal.

BRIGHTON

Featuring UV lacquer with an ultra high gloss finish for high impact. Brighton is eye catching and stylish in neutral grey and has a matching colour polymer edge on the doors and drawer fronts.



BRIGHTON
Light Grey Gloss
UV Lacquer



Principal.



Benchtops, splashback, handles, sinks, taps, appliances and accessories are available as optional extras

Principal.



Benchtops, splashback, handles, sinks, taps, appliances and accessories are available as optional extras

Principal.

MISSION BEACH

Brighten up your kitchen with Mission Beach white gloss doors and drawers. Great for rooms needing protection against light due to the UV lacquer finish.

MISSION BEACH
White Gloss
UV Lacquer

Principal.

FUJI WHITE

A stunning collection of ultra modern doors with a high gloss acrylic white finish and a stunning 3D glass effect edge - producing deceptively real glazed appearance. Pictured here in a galley design, the practical layout makes modern living easy and elegant.



FUJI WHITE
White Gloss
Acrylic



Principal.



Benchtops, splashback, handles, sinks, taps, appliances and accessories are available as optional extras

Principal.



Benchtops, splashback, handles, sinks, taps, appliances and accessories are available as optional extras

Principal.

JAPANESE PEAR

Featuring a luxurious 3D edge, the high gloss UV lacquer doors offer an exceptionally modern glass effect and deceptively real glazed appearance. The galley styled L-shaped layout, pictured here, maximises the available wall space whilst allowing plenty of room for entertaining friends and family.



JAPANESE PEAR
Woodgrain Gloss
UV Lacquer



Principal.

PURITY

A simple, yet sleek and modern high gloss white kitchen. The integrated J-pull handle routed into the door creates a sophisticated designer look and avoids the need for handles.



PURITY
White Gloss
2 pack paint



Principal.



Benchtops, splashback, handles, sinks, taps, appliances and accessories are available as optional extras

Principal.



Benchtops, splashback, handles, sinks, taps, appliances and accessories are available as optional extras

Principal.

SHAKER

Shaker's crisp white colour and satin texture combination creates a simple kitchen of striking contrasts.

Drawing its inspiration from the classic European Shaker door, is instantly appealing and works equally well in a small space as it does in a larger one.



SHAKER
White Satin
2 pack paint



Principal.

HAMPTON

Hampton is a timeless kitchen style and is immediately obvious why its appeal never diminishes. A classically styled white gloss finish with french cut detail and raised centre panel commands attention, whilst providing warmth and versatility to combine with a multitude of benchtop and splashback decors. Featured here is the Showcase glass door, a perfect match to the Hampton finish.



HAMPTON
White Gloss
2 pack paint



Principal.



Benchtops, splashback, handles, sinks, taps, appliances and accessories are available as optional extras

Principal.

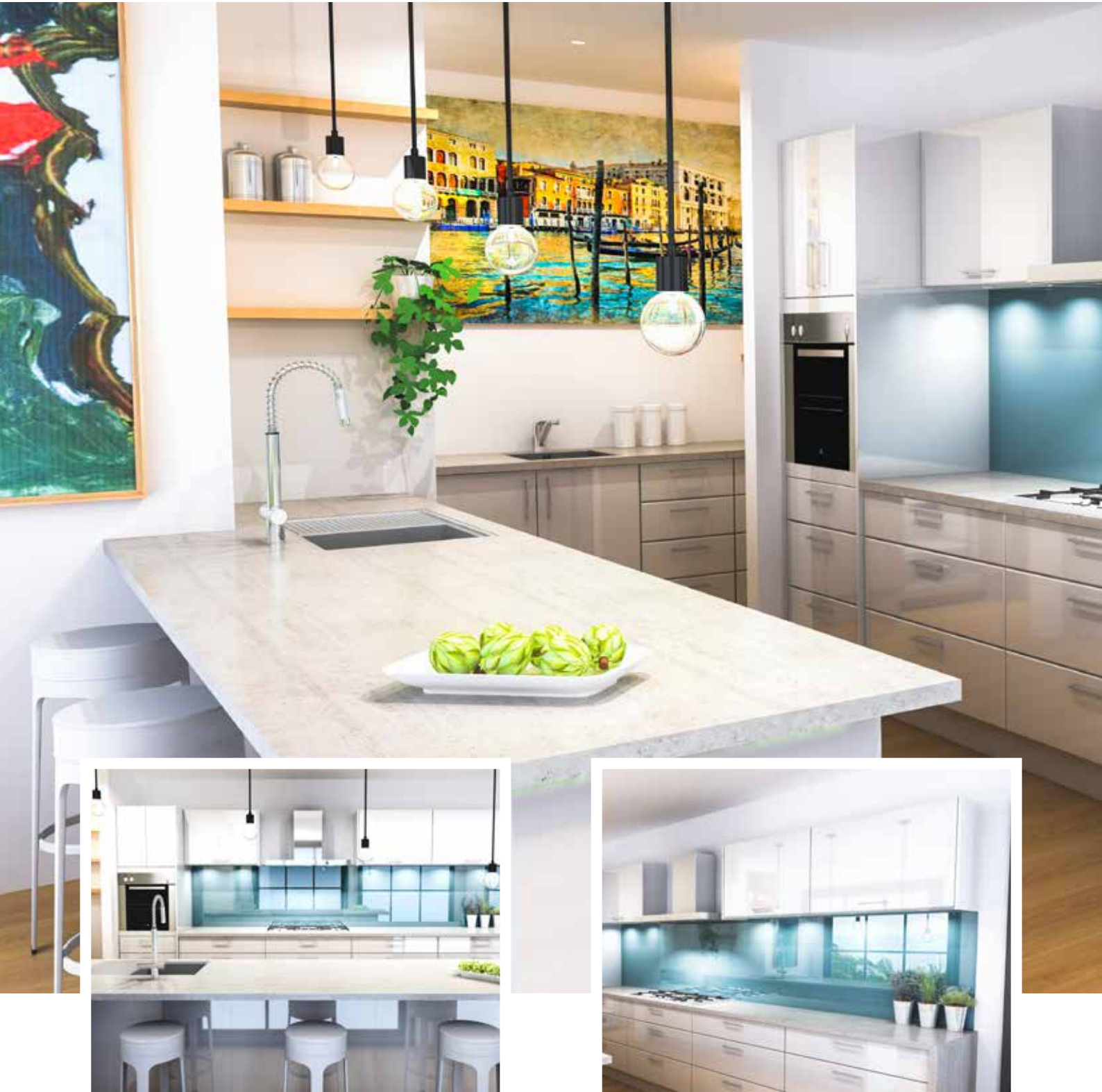

Benchtops, splashback, handles, sinks, taps, appliances and accessories are available as optional extras

Principal.

NEWPORT

Create the ultimate in crisp, sleek minimalist design with timeless gloss white Newport.

The cool gloss finish of this sleek, modern kitchen creates immediate impact in your home.

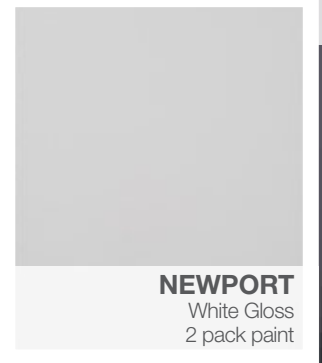

NEWPORT
White Gloss
2 pack paint



Principal.

SORRENTO

Effortlessly eye catching, the high gloss finish of this sleek, modern kitchen creates immediate impact in your home.

Features UV lacquered door with colour matched edging.



SORRENTO
Dark Grey Gloss
UV Lacquer



Principal.



Benchtops, splashback, handles, sinks, taps, appliances and accessories are available as optional extras

Principal.



Benchtops, splashback, handles, sinks, taps, appliances and accessories are available as optional extras

Principal.

BEAUMARIS

Chic in metallic grey, this kitchen has an ultra high gloss finish with an illuminating glass effect.



Principal.

KIRRA

Made and crafted in Italy, the Kirra style provides a modern matt white finish and seamless 2 pack painted door.



KIRRA
White Satin
2 pack paint



Principal.



Benchtops, splashback, handles, sinks, taps, appliances and accessories are available as optional extras

Principal.



Benchtops, splashback, handles, sinks, taps, appliances and accessories are available as optional extras

Principal.

ALLURE

This modern design features frosted toughened glass and aluminium frame shown here with mission beach doors and drawers. Add in cabinetry lighting to complete the look.



ALLURE
Frosted Glass
Aluminium Frame



Principal.

SHOWCASE

The Showcase overhead doors feature 4mm toughened glass, a gloss white finish frame and is crafted in Italy.

Paired here with the Principal Hampton doors, this style will give your kitchen an elegant and unique look.



SHOWCASE

White Gloss, Clear Glass
2 pack paint



Principal.



Benchtops, splashback, handles, sinks, taps, appliances and accessories are available as optional extras

Principal.



Benchtops, splashback, handles, sinks, taps, appliances and accessories are available as optional extras

Principal.

VISTA

The Vista Single pane Glass Door is a timeless kitchen style and is immediately obvious why its appeal never diminishes. A classically styled white Satin finish suits the Kirra & Shaker door finish and you can also mix and match with the array of colours from the Desire door range.

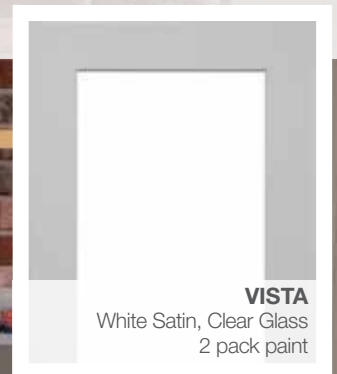

Principal.

LAUNDRY

Shown here in the Mission Beach option, match your laundry with your kitchen using all Principal doors and cabinetry to complete your style.



MISSION BEACH

White Gloss
UV Lacquer



Principal.



Benchtops, splashback, handles, sinks, taps, appliances and accessories are available as optional extras

Principal.

DESIRE PAINTED DOORS

The Desire painted door range has been developed to bring you unlimited options when designing your kitchen. You can choose from 4 unique door designs, unlimited colour options from the Dulux colour palette and two finishes.



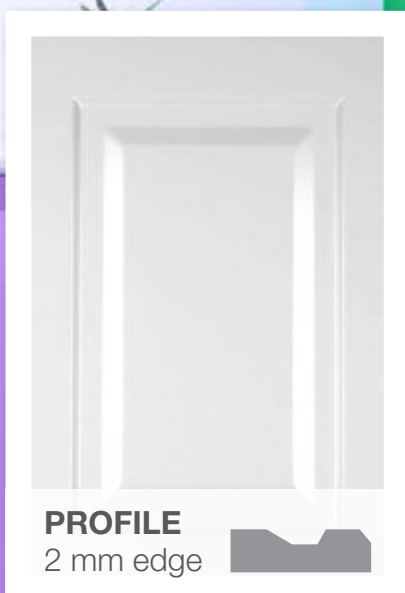
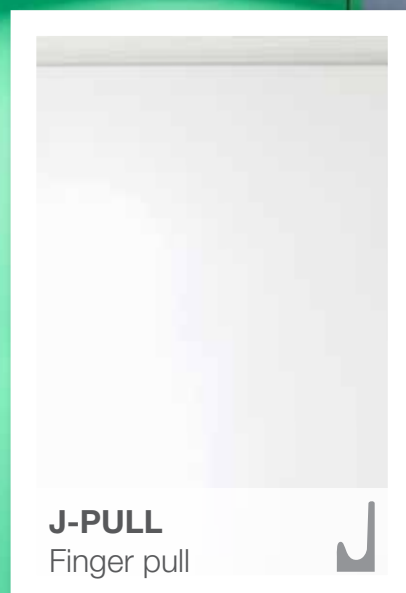
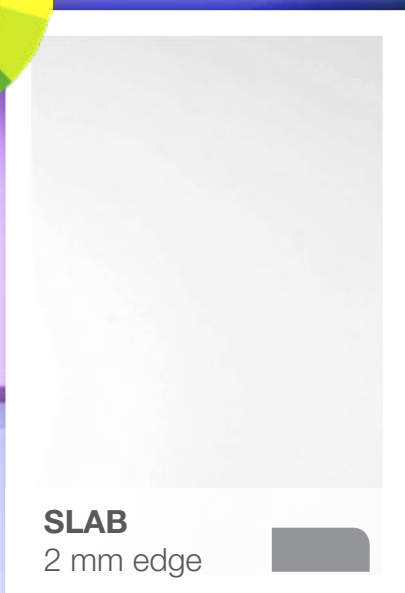

Principal.

ALFRESCO OUTDOOR KITCHEN

Available in 4 configurations with 6 compact laminate door front options. Designed with treated foam fill cabinetry for outdoor use, complete with granite benchtops to help create your ultimate outdoor dining experience.

Available in 6 door colours

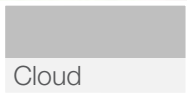

Cloud

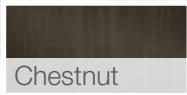

Chestnut

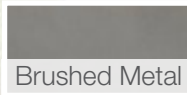

Brushed Metal

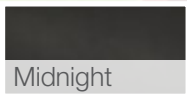

Midnight



Greywood



Vintage White

Available in 2 benchtop colours



Black Pearl



Steel Grey



CA 3
Cloud

Principal.



Principal.

CABINETS

Our Principal cabinetry range has a huge number of options from base, tall wall, short wall, oven, microwave, pantry, drawer as well as corner options.

All our cabinets are made in Australia from E1 moisture resistant particle board.

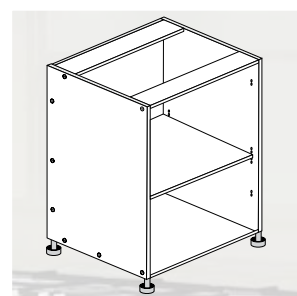

BASE CABINET

150, 200, 300, 350, 400, 450, 500, 600, 700, 800, 900, 1000 mm

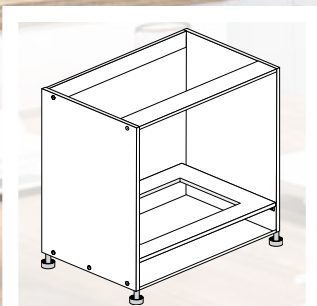

OVEN CABINET

600 & 900 mm

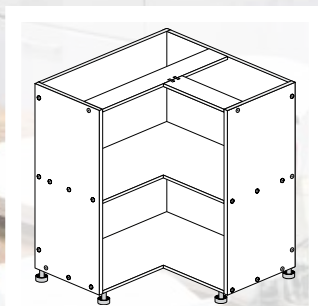

CORNER CABINET

900 x 900mm

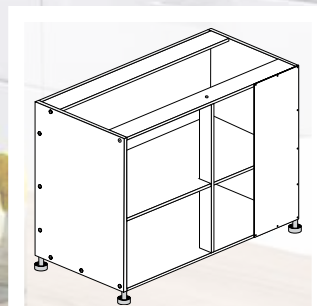

BLIND CNR CABINET

1100mm

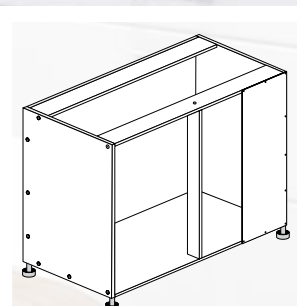

LEMANS CABINET COMBO

1100mm

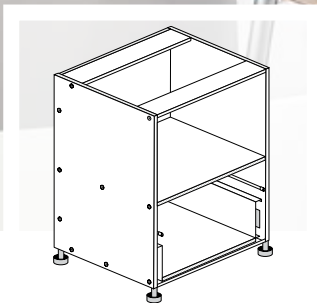

CABINET WITH 1 DRAWER

600mm

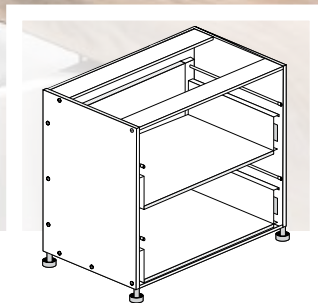

CABINET WITH 2 DRAWER

900mm

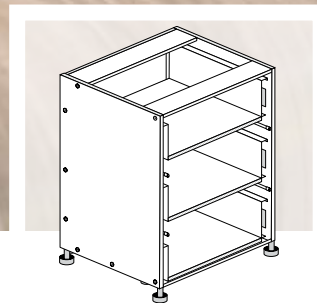

CABINET WITH 3 DRAWER

600, 800 & 900mm

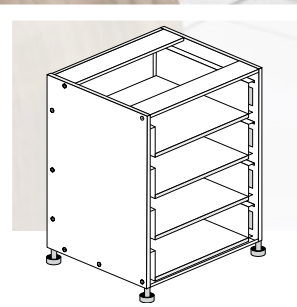

CABINET WITH 4 DRAWER

450mm

All drawers are soft close as standard

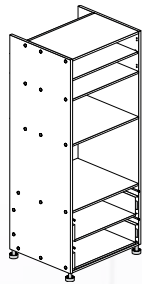

2 DRAWER OVEN TOWER
600mm, with microwave opening

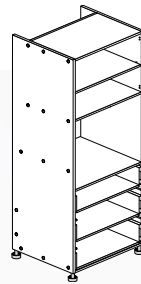

3 DRAWER OVEN TOWER
600mm

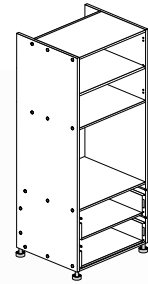

DOUBLE OVEN TOWER
600mm, with 2 drawers

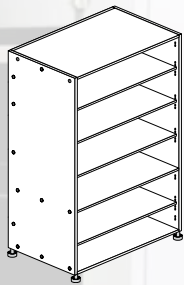

PANTRY CABINET
300, 400, 450, 600, 800 & 900mm

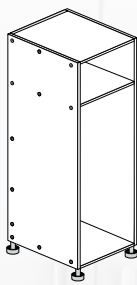

PULL OUT PANTRY
300mm
Mechanism sold separately

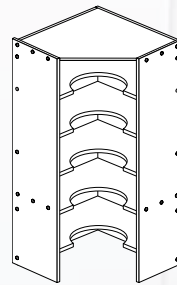

CORNER PANTRY
1010mm, 2204mm high

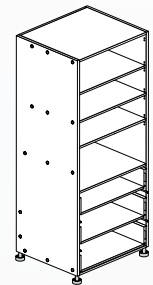

3 DRAWER PANTRY CABINET
600mm, internal drawers

Height 592mm

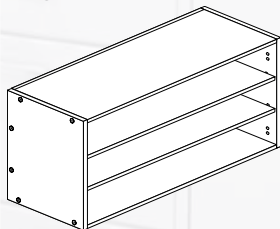

SHORT WALL CABINET
150, 200, 300, 350, 400, 450, 500, 600, 700, 800 & 900mm

Height 720mm

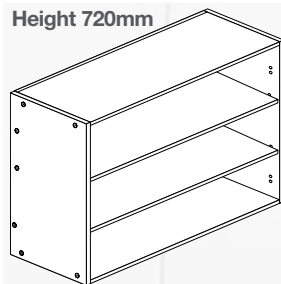

TALL WALL CABINET
150, 200, 300, 350, 400, 450, 500, 600, 700, 800 & 900mm

Height 592mm

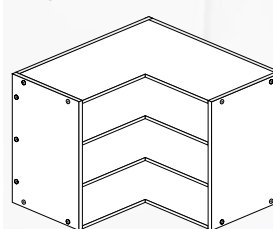

SHORT CORNER WALL CABINET
600 x 600mm

Height 720mm

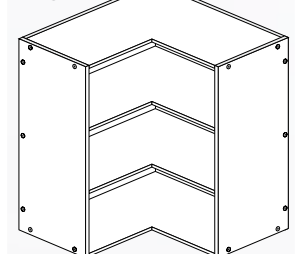

TALL CORNER WALL CABINET
600 x 600mm

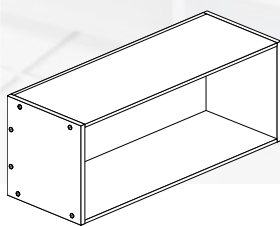

OVER FRIDGE CABINET
800, 900 & 1000mm

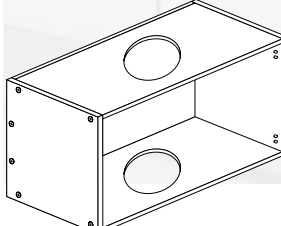

RANGEHOOD CABINET
600 & 900mm

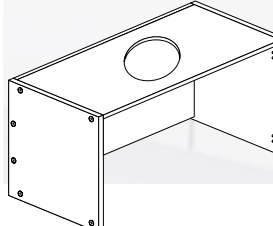

INTEGRATED RANGEHOOD
600 & 900mm

592mm High

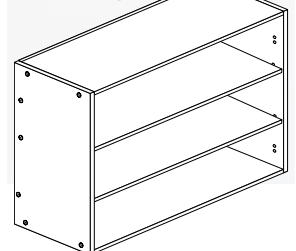

SHORT FREE FLAP CABINET
800 & 900mm

All drawers are soft close as standard

Laminate Benchtops

HÄFELE

Laminate benchtops are designed for applications such as kitchen benchtops, counter tops, bathroom vanities and laundry benchtops where a durable decorative surface is required.

Our laminate benchtop range is:

- Tough and durable
- Resistant to cracking and chipping
- Moisture resistant E0 (lightweight) LDF substrate
- Available in 33mm and 40mm
- Available in Gloss, Matt, Smooth and Matera finishes
- Made in Australia

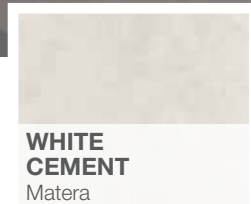
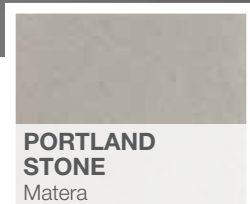
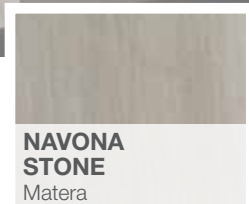
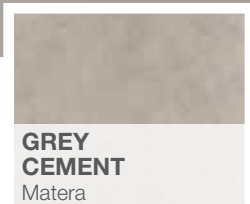
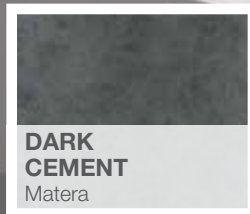
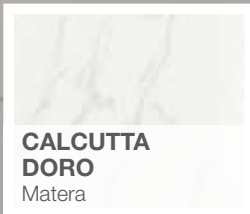

Principal.

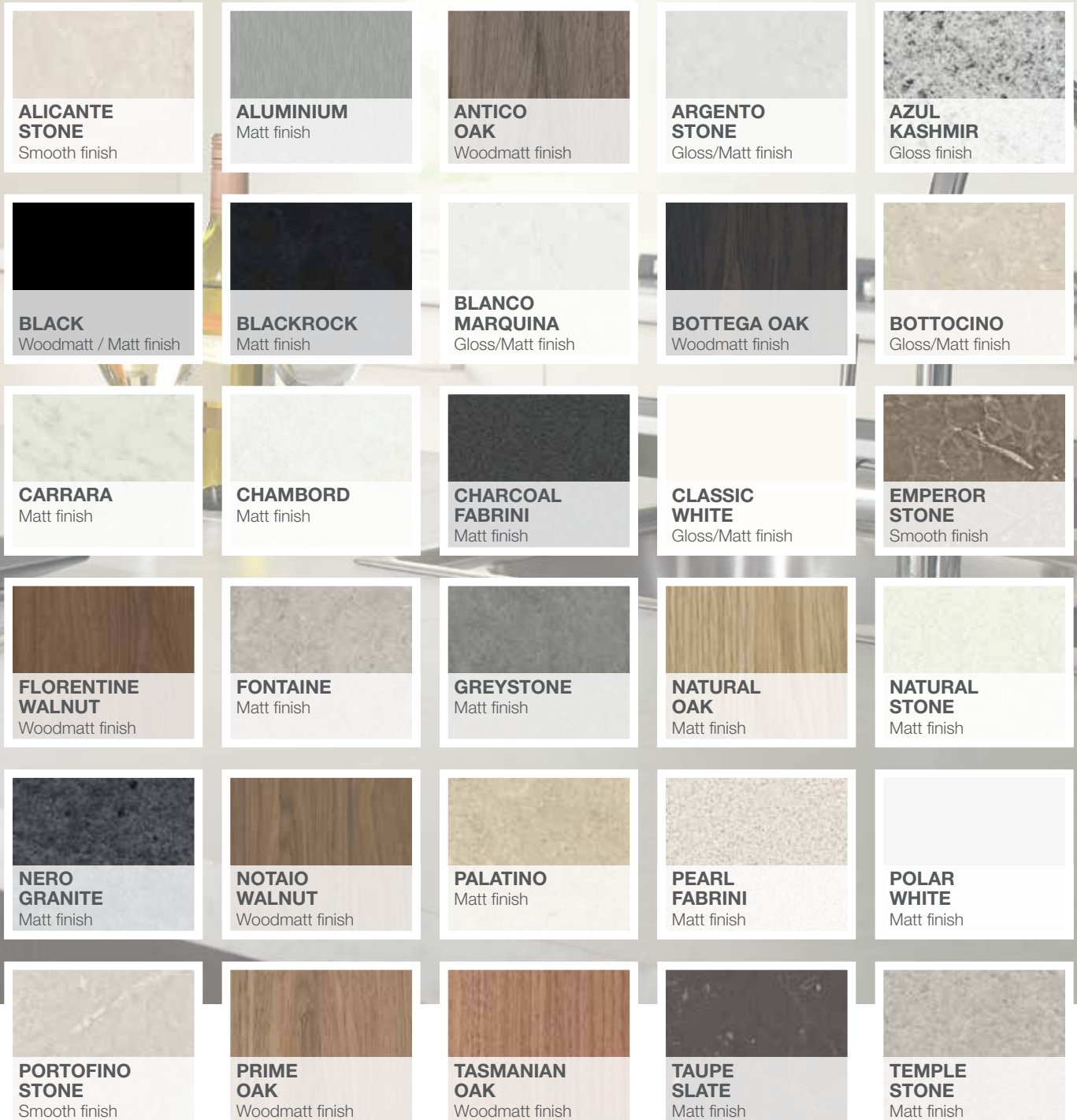

Standard Handles

HÄFELE



**MATT CHROME PLATED
T-BAR HANDLE**
135 x 35mm 491.41.906

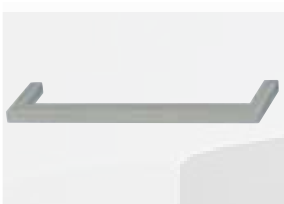

**MATT STAINLESS STEEL
D HANDLE**
170 x 35mm 491.41.056



**STAINLESS STEEL
D HANDLE**
136 x 27 mm 491.41.757



**MATT PLATED CHROME
D HANDLE**
128 x 25mm 491.42.054



**MATT PLATED CHROME
D HANDLE**
138 x 28mm 491.42.004

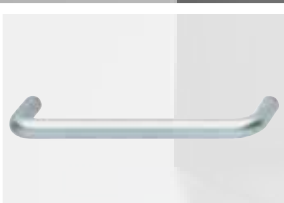

**MATT CHROME
D HANDLE**
106 X 35mm 491.06.215



**STAINLESS STEEL
D HANDLE**
172 x 25mm 491.42.207



**NICKEL MATT
BOW HANDLE**
148 x 30mm 491.42.359



**MATT PLATED CHROME
BOW HANDLE**
112 X 24mm 491.41.954



**MATT PLATED CHROME
PULL HANDLE**
172 x 24mm 491.61.026



**ANTIQUE IRON
D HANDLE**
136 x 33mm 491.41.504



**NICKEL-PLATED,
BRUSHED KNOB**
35 x 20mm 491.51.362



**ANTIQUE IRON
KNOB**
34 x 25mm 491.51.260



**ANTIQUE IRON
KNOB**
70 x 37mm 491.51.320



**POLISHED CHROME
KNOB**
20 x 25mm 491.51.380



**NICKEL MATT
KNOB**
30 X 23mm 491.01.210

Premium Handles

HÄFELE



**NICKEL-PLATED
BRUSHED, HANDLE**
232 x 28mm 491.42.756



**CHROME-PLATED,
POLISHED, HANDLE**
160 x 48mm 491.43.255



**OIL RUBBED BRONZE,
HANDLE**
176 x 32mm 106.61.124

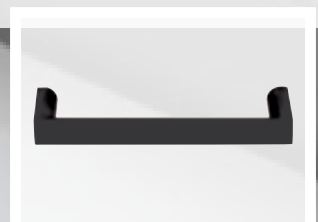

**MATT BLACK ZINC
D HANDLE**
168 x 27mm 491.41.032



**MATT BLACK
STEEL HANDLE**
168 x 35mm 491.41.041



**CHROME PLATED
POLISHED HANDLE**
220 x 30mm 491.41.090

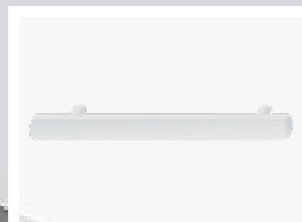

**WHITE MATT ZINC
HANDLE**
220 x 30mm 491.41.092



**BLACK MATT ZINC
HANDLE**
220 x 30mm 491.41.093



**BLACK MATT ZINC
HANDLE**
170 x 28mm 491.41.110



**WHITE MATT ZINC
HANDLE**
170 x 28mm 491.41.112



**BLACK MATT ZINC
HANDLE**
138 x 28mm 491.41.120



**CHROME PLATED
POLISHED HANDLE**
180 x 28mm 491.41.130

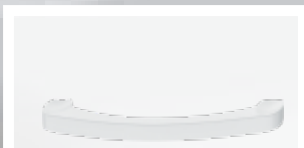

**MATT WHITE ZINC
HANDLE**
180 x 28mm 491.41.134



**MATT WHITE ZINC
HANDLE**
212 x 28mm 491.41.135



**MATT BLACK ZINC
HANDLE**
180 x 28mm 491.41.136



**MATT BLACK ZINC
PULL HANDLE**
172 x 24mm 491.41.140

Appliances

milano
BY HÄFELE



**60CM FREESTANDING
DISHWASHER**

535.29.550



**60CM BUILT-IN
MICROWAVE**

538.31.370



**60CM
5 FUNCTION OVEN**

Basic timer 538.01.151



**60CM
5 FUNCTION OVEN**

Digital clock & timer 538.01.161



**60CM
9 FUNCTION OVEN**

Digital clock & timer 538.01.171



**60CM 4 BURNER
GAS COOKTOP**

Enamel trivet 538.01.871



**60CM 4 BURNER
GAS COOKTOP**

Cast iron trivet 538.01.881



**90CM 5 BURNER GAS
COOKTOP**

Cast iron trivet 538.01.893



**60CM CERAMIC
COOKTOP**

Knob control 538.01.901

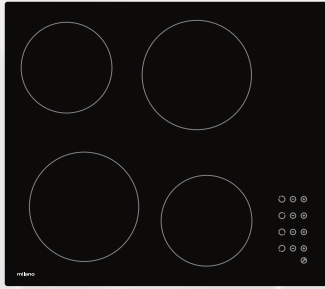

**60CM CERAMIC
COOKTOP**

Touch control 538.01.911



**90CM CERAMIC
COOKTOP**

Touch control 538.01.933



**60CM INDUCTION
COOKTOP**

538.01.921



**60CM BUILT-IN
RANGEHOOD**

538.80.071



**90CM BUILT-IN
RANGEHOOD**

538.80.073

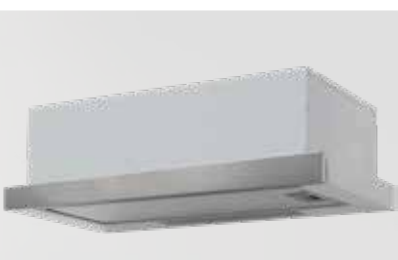

**60CM SLIDE-OUT
RANGEHOOD**

538.81.121



**60CM TAPERED
CANOPY RANGEHOOD**

538.81.131



**90CM TAPERED
CANOPY RANGEHOOD**

538.81.133

Alusion Splashbacks

Aluminum composite splashbacks, a sleek and modern alternative to glass, acrylic and tiled splashbacks, Alusion is a versatile choice for those looking for an affordable yet durable kitchen splashback material. Its perfectly smooth surface in high gloss or matt finish and modern colour selection will make your kitchen stand out from the rest!



**SUNSET ILLUSION
GLOSS**

Alusion



**SPECTRA COPPER
GLOSS**

Alusion



**SPECTRA PURPLE
GLOSS**

Alusion



**NANO FLASH
SILVER GLOSS**

Alusion



**DARK GREY
MATT**

Alusion



**CHAMPAGNE
SILVER MATT**

Alusion



**SILVER GREY
MATT**

Alusion



**DARK GREY
SILVER MATT**

Alusion

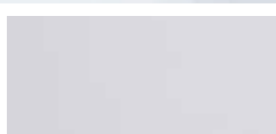

**PEARL WHITE
GLOSS**

Alusion



**PEARL BLACK
GLOSS**

Alusion



**FLASH SILVER
MATT**

Alusion



**CHAMPAGNE
MATT**

Alusion



**NANO WHITE
SILVER GLOSS**

Alusion



**NANO CHAMPAGNE
SILVER GLOSS**

Alusion



**FLASH GREEN
MATT**

Alusion



**METALLIC BLUE
MATT**

Alusion



HÄFELE QUARTZ COMPOSITE SINK BENEFITS

HÄFELE Quartz Sinks are up to 80% natural quartz sand and have been specifically developed for the demands of the kitchen.

Manufactured in Germany our quartz composite sinks come with push pull wastes, connections, overflow assembly, clips for lay on or under mounting and a generous 20 year guarantee.



The rigors of every day use vanish with hardly a trace.



Heat resistant



Impact resistant



Dirt repellent



Stain resistant



Made to last



Food safe



Odour free



Hygienic

Sinks

HÄFELE

QUARTZ
COMPOSITE SINKS



Onyx Quartz

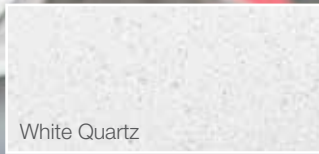

White Quartz

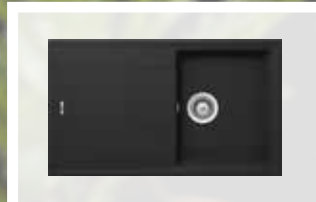

SINGLE BOWL WITH DRAINER

ONYX 570.35.300
WHITE 570.35.700



1 & 1/4 BOWL SINK WITH DRAINER

ONYX 570.35.310
WHITE 570.35.710

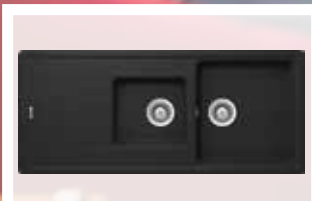

1 & 3/4 BOWL SINK WITH DRAINER

ONYX 570.36.360
WHITE 570.37.700

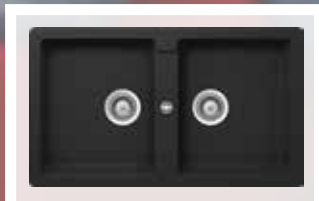

DOUBLE BOWL SINK

ONYX 570.36.370
WHITE 570.37.710

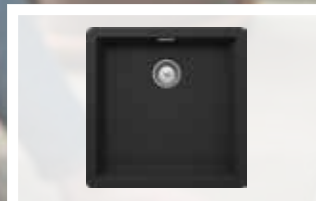

SINGLE BOWL SINK

ONYX 570.36.380
WHITE 570.37.720



SINGLE BOWL LAUNDRY SINK

ONYX 570.36.390
WHITE 570.37.730

Linen
TEXTURED SINKS



Stainless Steel



Gun Metal



SINGLE BOWL SINK

Stainless Steel 567.30.776
Gun Metal 567.30.856



1 & 3/4 BOWL SINK

Stainless Steel 567.30.766
Gun Metal 567.30.866



DOUBLE BOWL SINK

Stainless Steel 567.30.746
Gun Metal 567.30.846

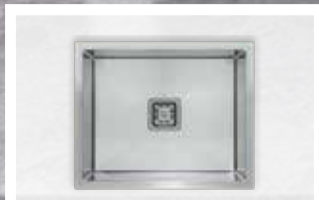

LAUNDRY SINK

Stainless Steel 567.30.776
Gun Metal 567.30.876



DRAINER TRAY

Stainless Steel 567.34.974
Gun Metal 567.34.975



COLANDER

Stainless Steel 567.34.952
Gun Metal 567.34.953

SQUARELINE SINKS



SINGLE BOWL SINK
Stainless steel 567.30.246



1 & 1/2 BOWL SINK
Stainless steel 567.30.256



DOUBLE BOWL SINK
Stainless steel 567.30.266

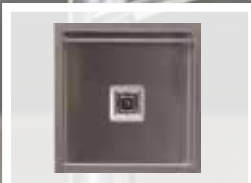

SINGLE BOWL SINK
Stainless steel 567.33.056



1 & 3/4 BOWL SINK
Stainless steel 567.33.076

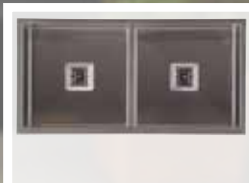

DOUBLE BOWL SINK
Stainless steel 567.33.066



LAUNDRY SINK
Stainless steel 567.33.046



DRAINER TRAY
Stainless steel 567.34.971



UNIVERSAL DRAINER MAT
567.34.970



WIRE BASKET
567.34.910



CHOPPING BOARD
567.34.930



COLANDER
567.34.951

Essentials SINKS



* Right hand drain shown
SINGLE BOWL SINK
Right hand 567.01.024
Left hand 567.01.025



* Right hand drain shown
1 & 3/4 BOWL SINK
Right hand 567.30.110
Left hand 567.30.010



* Right hand drain shown
DOUBLE BOWL SINK
Right hand 567.30.100
Left hand 567.30.000



UNDERMOUNT SINGLE BOWL SINK
567.33.130



UNDERMOUNT 1 & 3/4 BOWL SINK
567.33.116



UNDERMOUNT DOUBLE BOWL SINK
567.33.106



LAUNDRY TUB
567.30.120



ROUND BOWL SINK
567.56.000



DRAINER TRAY
567.34.973



BYPASS KIT
567.34.980



DOUBLE BOWL SINK ACCESSORY PACK
567.34.900



1 & 3/4 BOWL SINK ACCESSORY PACK
567.34.901

Tapware

HÄFELE



MIXER TAP
4 Star WELS rating,
6.5 Litres per minute
Polished chrome 566.58.200

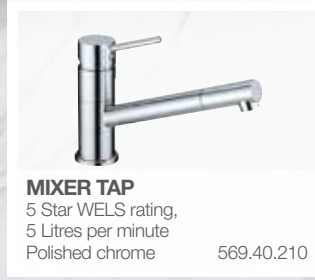

MIXER TAP
5 Star WELS rating,
5 Litres per minute
Polished chrome 569.40.210



MIXER TAP with pull-out vegi spray
4 Star WELS rating,
6.5 Litres per minute
Polished chrome 569.40.220



MIXER TAP Gooseneck
5 Star WELS rating,
5 Litres per minute
Polished chrome 569.58.220



MIXER TAP with flexible extension
4 Star WELS rating,
6.5 Litres per minute, Black
Polished chrome 566.58.230



MIXER TAP rectangle gooseneck
4 Star WELS rating,
6.5 litres per minute
Polished chrome 569.40.230



MIXER TAP squareline
4 Star WELS rating,
6.5 Litres per minute
Polished chrome 569.40.250



MIXER TAP squareline gooseneck
4 Star WELS rating,
6.5 litres per minute
Polished chrome 569.40.240



MIXER TAP flexible gooseneck
5 Star WELS rating,
5 litres per minute
Polished chrome 569.40.260

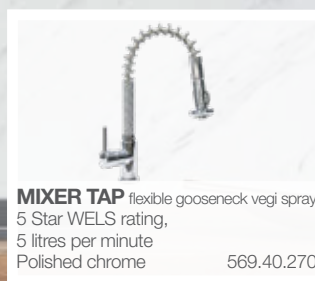

MIXER TAP flexible gooseneck vegi spray
5 Star WELS rating,
6.5 Litres per minute
Polished chrome 569.40.270



MIXER TAP Gooseneck
5 Star WELS rating,
5 Litres per minute
Polished chrome 569.40.290



MIXER TAP Gooseneck
4 Star WELS rating,
6.5 Litres per minute
Stainless steel 569.41.030



MIXER TAP Gooseneck
4 Star WELS rating,
6.5 Litres per minute
Gun metal 566.69.340



MIXER TAP Flat
4 Star WELS rating,
6.5 Litres per minute
Polished chrome 569.41.250



MIXER TAP Gooseneck
5 Star WELS rating,
5 Litres per minute
Matt black 569.41.310



MIXER TAP with pull-out vegi spray
4 Star WELS rating,
6.5 Litres per minute
Polished chrome 569.40.200



MIXER TAP flat
4 Star WELS rating,
6.5 Litres per minute
Black chrome 566.68.301



MIXER TAP flat
4 Star WELS rating,
6.5 Litres per minute
Matt black 566.68.311



MIXER TAP flat
6 Star WELS rating,
4.5 Litres per minute
Matt black 566.68.321

Filtration

HÄFELE



PREMIUM WATER FILTRATION KIT
With dedicated tap
Polished chrome 566.69.260



PREMIUM WATER FILTRATION KIT
With dedicated tap
Polished chrome 566.69.982



H2O PLATINUM INLINE FILTRATION KIT
Installation with existing tap 566.69.980



REPLACEMENT FILTER CARTRIDGE
WFA Water filter
Harsh hiflow 566.69.981



REPLACEMENT FILTER CARTRIDGE
WFA Water filter
Classic 566.69.983

Pantry Solutions

The Principal Range utilises Kesseböhmer by Häfele to add functionality to your kitchen. Manufactured in Germany, Kesseböhmer by Häfele accessories are the perfect combination of style and practicality.

HÄFELE
KESSEBÖHMER





KESSEBÖHMER DISPENSA
 Chrome Arena Style 546.51.321
 Anthracite Arena Style 546.45.411



KESSEBÖHMER CONVOY CENTRO
 Glass Arena Vario 545.81.683



KESSEBÖHMER TANDEM
 Chrome Arena Style 545.94.612
 Anthracite Arena Style 545.93.431



KESSEBÖHMER CONVOY LAVIDO
 Glass Arena Vario 549.62.516
 Anthracite Arena Style 549.63.916



ANTHRACITE ARENA STYLE



CHROME ARENA STYLE

Base Storage

HÄFELE
KESSEBÖHMER



KESSEBÖHMER NO15 ARENA STYLE
2 Tier pullout 549.24.320



KESSEBÖHMER NO15 ARENA STYLE
Towel rail pullout 549.24.333



KESSEBÖHMER NO15 ARENA STYLE
Baking tray pullout 549.24.343



KESSEBÖHMER COMFORT II PULLOUT R/H, LEFT MOUNT
Chrome Arena Style 545.53.674
Anthracite Style 545.53.477



KESSEBÖHMER DISPENSA JUNIOR III
Arena Style 545.11.614



HÄFELE 150MM SMALL & LARGE WIRE PULLOUT
Wire baskets 495.35.000



HÄFELE PULLOUT STORAGE UNIT
Wire baskets 545.26.293



HÄFELE DOUBLE SOFT CLOSE PULL OUT STORAGE BASKETS, SMALL & LARGE
450mm 495.34.022
600mm 495.34.023



KESSEBÖHMER CLEANING AGENT PULLOUT
White Plastic 549.24.912



KESSEBÖHMER COOKING AGENT PULLOUT
Silver plastic 549.24.972



KESSEBÖHMER PORTERO I
White /Chrome 545.48.760



KESSEBÖHMER PORTERO II
White /Chrome 545.48.761

Corner Solutions

HÄFELE
 KESSEBÖHMER *ninka*



**KESSEBÖHMER
LE MANS II CORNER
UNIT, (Right Hand)**
 Arena Style RH 541.32.620
 Arena Style LH 541.32.621



**KESSEBÖHMER
LE MANS II CORNER
UNIT, (Right Hand)**
 Anthracite Arena RH 541.31.870
 Anthracite Arena LH 541.31.871



**BLIND CORNER
CABINET & LE MANS
COMBO UNIT,**
 RH 561.00.370
 LH 561.00.371



**HÄFELE SOFT CLOSE
MAGIC CORNER UNIT**
 Wire basket LH & RH 548.16.202



**KESSEBÖHMER
MAGIC CORNER**
 Arena Classic RH 546.17.602
 Arena Classic LH 546.17.603



**NINKA MONDO CORNER
REVOLVING UNIT**
 542.24.813



**KESSEBÖHMER
270 CAROUSEL UNIT**
 Arena Classic 542.31.250



**NINKA CORNER
CAROUSEL UNIT**
 White plastic 541.45.837



**ANTHRACITE
ARENA STYLE**



**CHROME
ARENA STYLE**



**CHROME
ARENA CLASSIC**

Overhead Storage

HÄFELE
 KESSEBÖHMER



**KESSEBÖHMER iMOVE
 SINGLE SHELF**

White 504.68.617
 Anthracite 504.68.313



**KESSEBÖHMER iMOVE
 DOUBLE SHELF**

White 504.68.623
 Anthracite 504.68.323



FREE FLAP CABINET

800mm 561.02.164
 900mm 561.02.163

Drawer Organisation



FINELINE CUTLERY INSERT
To suit 450mm drawer
Natural Oak 556.03.400



NINKA CUSIO CUTLEY INSERT
To suit 450mm drawer
Translucent white 556.24.842



NINKA CUSIO CUTLEY INSERT
To suit 900mm drawer
Translucent graphite 556.24.962



HÄFELE CLASSIC CUTLERY TRAY
To suit 600mm drawer
Silver 495.42.004



HÄFELE SMART CUTLERY TRAY - ALTO
To suit 450mm drawer
495.42.001



HÄFELE CLASSICO CUTLERY TRAY
To suit 900mm drawer
White 495.42.007



HÄFELE GRIP CUTLERY TRAY
To suit 600mm drawer
Anthracite Pearl 495.42.008



HÄFELE SMART CUTLERY TRAY
To Suit 600mm drawer
White 556.60.789



HÄFELE SPICE RACK INSERT
To suit 450mm drawer
White 495.42.009

Waste & Laundry Management

HÄFELE

ninka **Hailo**



HÄFELE 10L DOOR MOUNTED WASTE BIN

White, suits 400mm cabinet
495.43.000



HÄFELE 10L DOOR MOUNTED WASTE BIN

Chrome, suits 400mm cabinet
495.43.001



HAILO 5L DOOR MOUNTED BIN

Suits 300mm cabinet
495.43.003



HAILO 18L DOOR MOUNTED BIN

Suits 450mm cabinet
495.43.042



HÄFELE 1 X 40L SINGLE PULL OUT WASTE BIN

Suits 400mm cabinet
502.70.520



HÄFELE 2 X 15L SOFT CLOSE, DOUBLE PULL OUT BIN

Suits 400mm cabinet
495.43.031

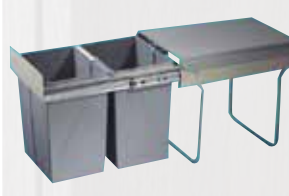

HÄFELE 2 X 20L SOFT CLOSE, DOUBLE PULL OUT BIN

Suits 400mm cabinet
495.43.030



NINKA 4.2L BIO BIN

Suits 400mm cabinet
495.43.002



**HAILO 2 X 38L DOUBLE
PULL OUT WASTE BIN**

Suits 450mm cabinet

503.70.332



**HAILO 2 X 15L DOUBLE
PULL OUT BIN**

Suits 300mm cabinet

495.43.004



**HAILO 2 X 18L DOUBLE
PULL OUT BIN**

Suits 400mm cabinet

495.43.005



**HÄFELE WORKTOP
WASTE BIN**

5L, 237 W x 205 D x 230 H
502.94.002

11L, 310 W x 280 D x 300 H
502.94.000



**HAILO 2 X 33L LAUNDRY
PULL OUT HAMPER**

Suits 450mm cabinet

502.72.722



**HÄFELE 1 X 40L OSKA
LAUNDRY HAMPER**

Suits 500mm cabinet

495.43.300



**HÄFELE IRONFIX
DRAWER MOUNT
IRONING BOARD**

White, Suits 450mm Drawer unit
568.60.710



**450MM CABINET AND 2X
20L OSKA WASTE BIN
COMBO**

561.00.015

Accessories

HÄFELE 

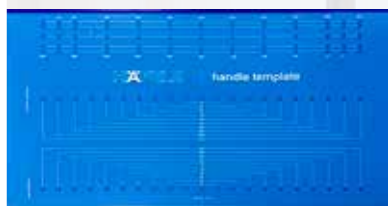

HANDLE JIG TEMPLATE

001.35.090



SHOWCASE GLASS SHELF

To suit 300 Wall Cabinet (2pk) 543.09.401
 To suit 400 Wall Cabinet (2pk) 543.09.402
 To suit 450 Wall Cabinet (2pk) 543.09.403
 To suit 600 Wall Cabinet (2pk) 543.09.404
 To suit 800 Wall Cabinet (2pk) 543.09.405
 To suit 900 Wall Cabinet (2pk) 543.09.406



HÄFELE WINE GLASS RACK

Chrome

544.09.200



**HÄFELE TOWEL RAIL
EXTENDABLE 2 ARM**

Silver

495.05.001



**HÄFELE K PUSH
PUSH TO OPEN, FOR DOORS**

White

356.12.013



**HÄFELE MOBILE PLATE
CARRIER**

Small

495.42.105



HAILO STEP STOOL

White Grey

505.04.704



**HÄFELE PROTECTION RAILS
300MM LONG**

Stainless Steel

808.90.090

Lighting

HÄFELE



**HÄFELE DOWNLIGHT 12V
2 PIECE KIT**

Warm White 450.72.410
Cool White 450.72.412



**HÄFELE DOWNLIGHT 12V
3 PIECE KIT**

Warm White 450.72.414
Cool White 450.72.416



**HÄFELE 5M STRIP LIGHTING
12V LIGHT KIT**

Warm White 450.72.404
Cool White 450.72.408



DRAWER SENSOR LIGHT

Daylight White 833.87.020



**HÄFELE BLUETOOTH
SOUND SYSTEM**

12V 450.72.418



HÄFELE CONNECT BLE BOX

For controlling lighting through Häfele
lighting app wirelessly

850.00.005

Planning tips

WHAT TO DO

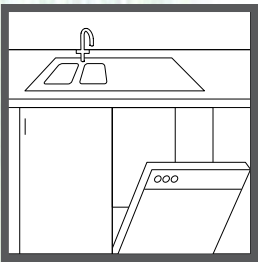

For ease of plumbing, place a dishwasher near the sink and allow a minimum 600mm space to 'house' it.

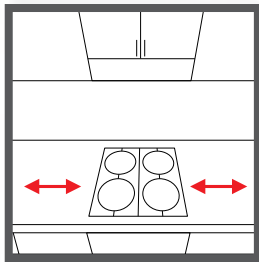

Allow a minimum 450mm either side of the cooktop for safety and extra working space.

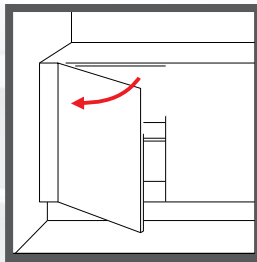

Leave space between a cabinet and your wall so doors can be fully opened and the cabinet easily accessed.

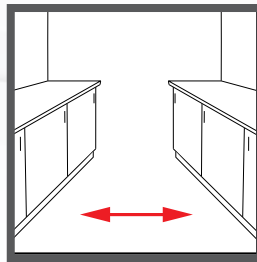

Allow a minimum 1.2m between opposite cabinets for maneuverability.

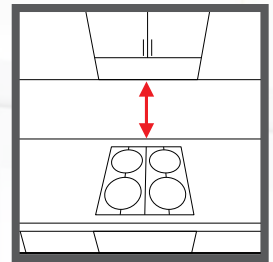

Allow a minimum 650mm between your cooktop and rangehood.

WHAT NOT TO DO

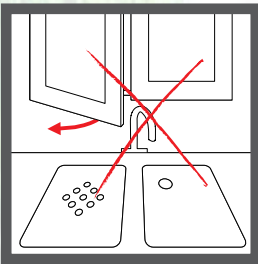

Don't place tall tapware in front of an opening window.

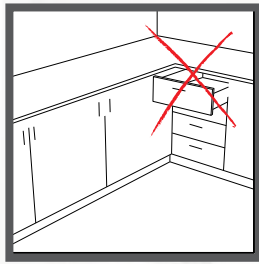

Don't place drawers in a corner where they can block other cabinets.

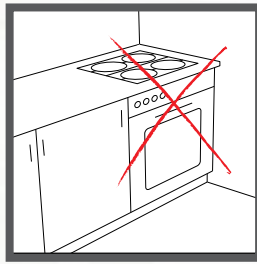

Don't place a cooktop next to a wall where it can cause overheating. Allow a minimum 450mm on either side.

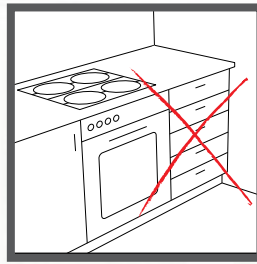

Don't install a full set of drawers next to a cooktop. This can provide easy access to a hot cooking area for young children.

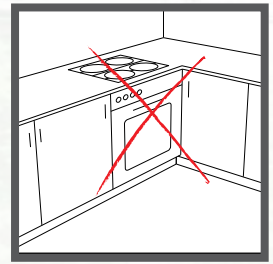

Don't place your dishwasher or stove in a corner where it can block other cabinets.

Design hints & tips

Kitchen design example

Shown here is a sample of a kitchen design. This design highlights the cupboards used, and indicates where panels should be used. You'll notice that we have marked in a solid line, indicating the wall perimeter of the kitchen.

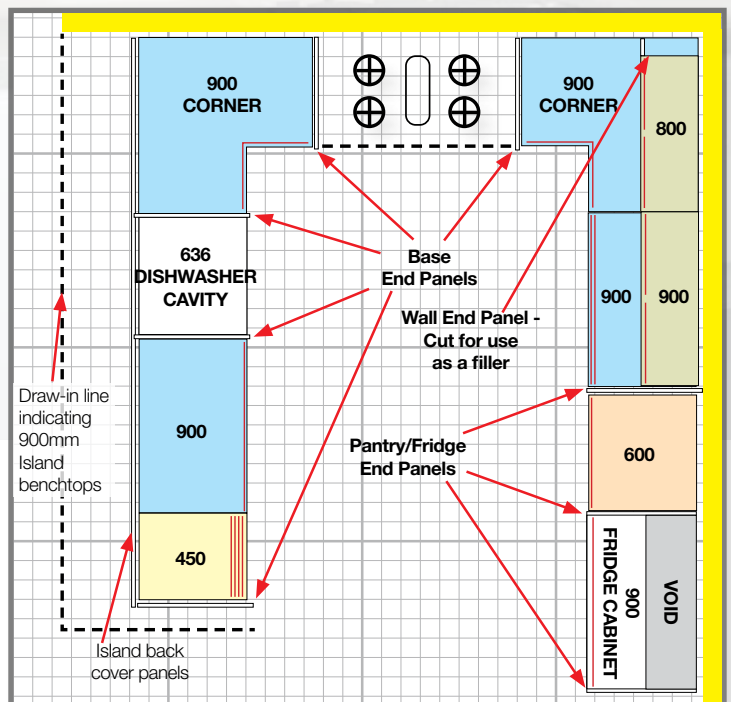

End Panels & Cavities

TYPES OF PANELS AND THEIR PURPOSES

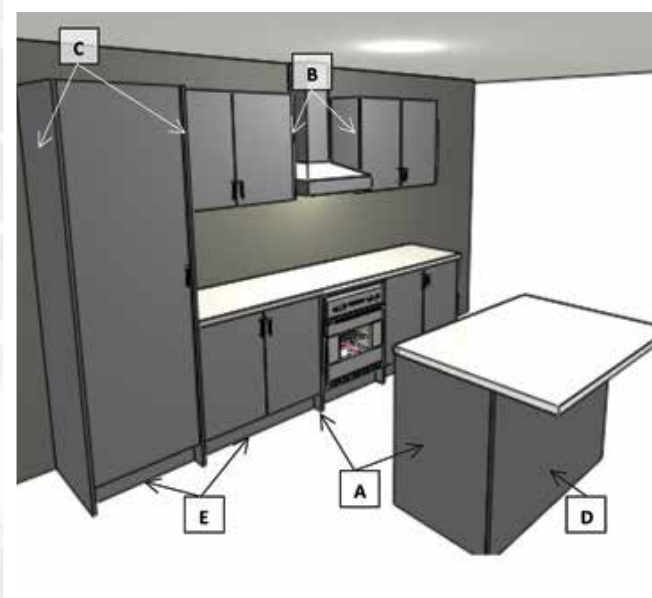

There are five types of panel you can install to give your new kitchen a clean finish. Each panel has a different purpose, explained below.

A. Base End Panel

Finishing exposed sides of base cabinets; placed either side of dishwasher cavity.

B. Wall End Panel

Finishing exposed sides of wall cabinets; used as filler panels (after cutting).

C. Pantry End Panel

Finishing exposed sides of pantry cabinets; to create a fridge box (the sides of the fridge wall cabinet); used as filler panels.

D. Island Back Panel

Finishing the cabinet backs of an island bench.

E. Kickboard

Hides adjustable feet of the base and pantry cabinets.

KITCHEN CAVITIES

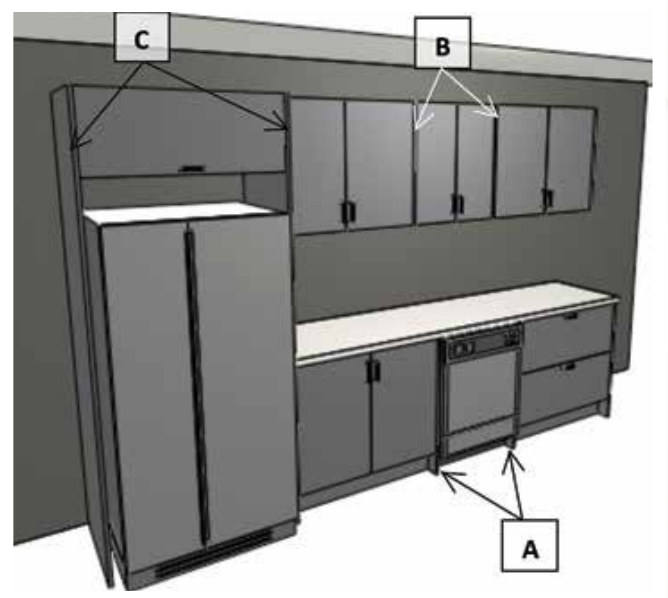

Here are some useful measurements when planning out your kitchen cavities, commonly spaces for dishwasher and fridge.

Dishwasher cavity: Leave a space of 636mm or more between two base cabinets. Base end panels are 18mm thick, so when you fix a panel to each exposed cabinet side there'll be at least 600mm of space for your dishwasher.

When using end panels for a dishwasher cavity, use wall end panels either side of a 600mm wall cabinet to keep alignment of your base and wall cabinets.

Fridge cavity: A space of 900mm in width should be sufficient, but check before you go ahead. You can also choose to mount an overhead fridge cabinet, between two pantry end panels. As the image shows, the fridge wall cabinet will mount to the front of the pantry end panels.

Measuring tips

The first thing you need when you're thinking about a new kitchen is a working plan of your space. It's your starting point for designing, costing and building your perfect kitchen. We'll show you how to measure your kitchen space, locate your various services and fixtures, and then sketch your space on the grid provided. With this sketch, you'll be able to plot a kitchen that suits your space and your needs. It is well worth taking the time to do this step correctly. It doesn't have to be a work of art, but it does need to be accurate.

1. Begin by measuring your walls

When measuring the widths of your walls, ideally measure at approximately 1m from the floor, keeping the measuring tape taut at all times (grab a friend to help with this step!). Starting in one corner of the room, measure to the adjacent wall and write down the measurement in millimetres. Go all around the room until all walls are measured. On a spare piece of paper, create a quick, rough sketch of your room shape and note your measurements against it as you move around the room. This will help to ensure you don't accidentally muddle up your measurements later on!

2. Measure your ceiling height

You'll need to know where to position the cabinetry on your wall, and that you have enough room for them. It's best to measure your ceiling height in several places, as floors can be uneven. Write down your measurements.

3. Create a sketch

Use the grid on the next page to create a sketch of your kitchen floor plan, and then transfer your measurements. See above for example.

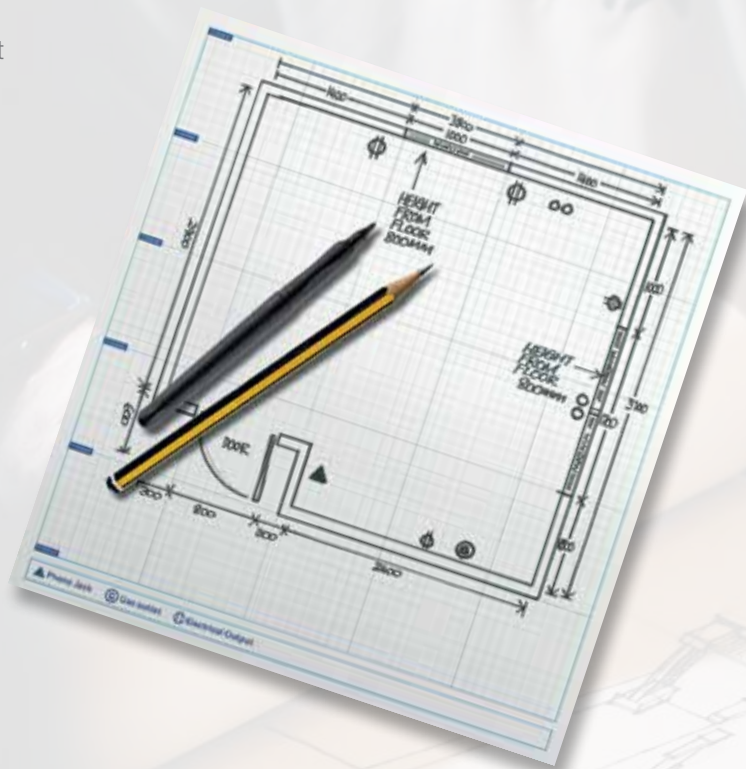

4. Measure your fixtures

Measure any windows and doors, remembering to always measure from the outside edge of the architrave. Also take measurements of their location on the wall, i.e. how far is the window located from the corner of the wall and how high is it from the floor.

5. Locate your services

Find all your utility and services like electrical points, gas and plumbing and mark the relevant symbols onto your plan. Again, remember to note their height and position on the wall.

Symbols for the different utilities are shown below.

UTILITIES SYMBOLS



PHONE JACK



GAS OUTLET



ELECTRICAL OUTPUT



WATER OUTPUT

If you're still a bit uncertain about measuring up your kitchen properly, ask one of our kitchen expert's in-store for more information.

Design Space

Measure and map out doors and windows.
Make a note of which way they open.
Locate and mark your plumbing and electrical outlets.
Transfer all your measurements to the grid, and start designing!

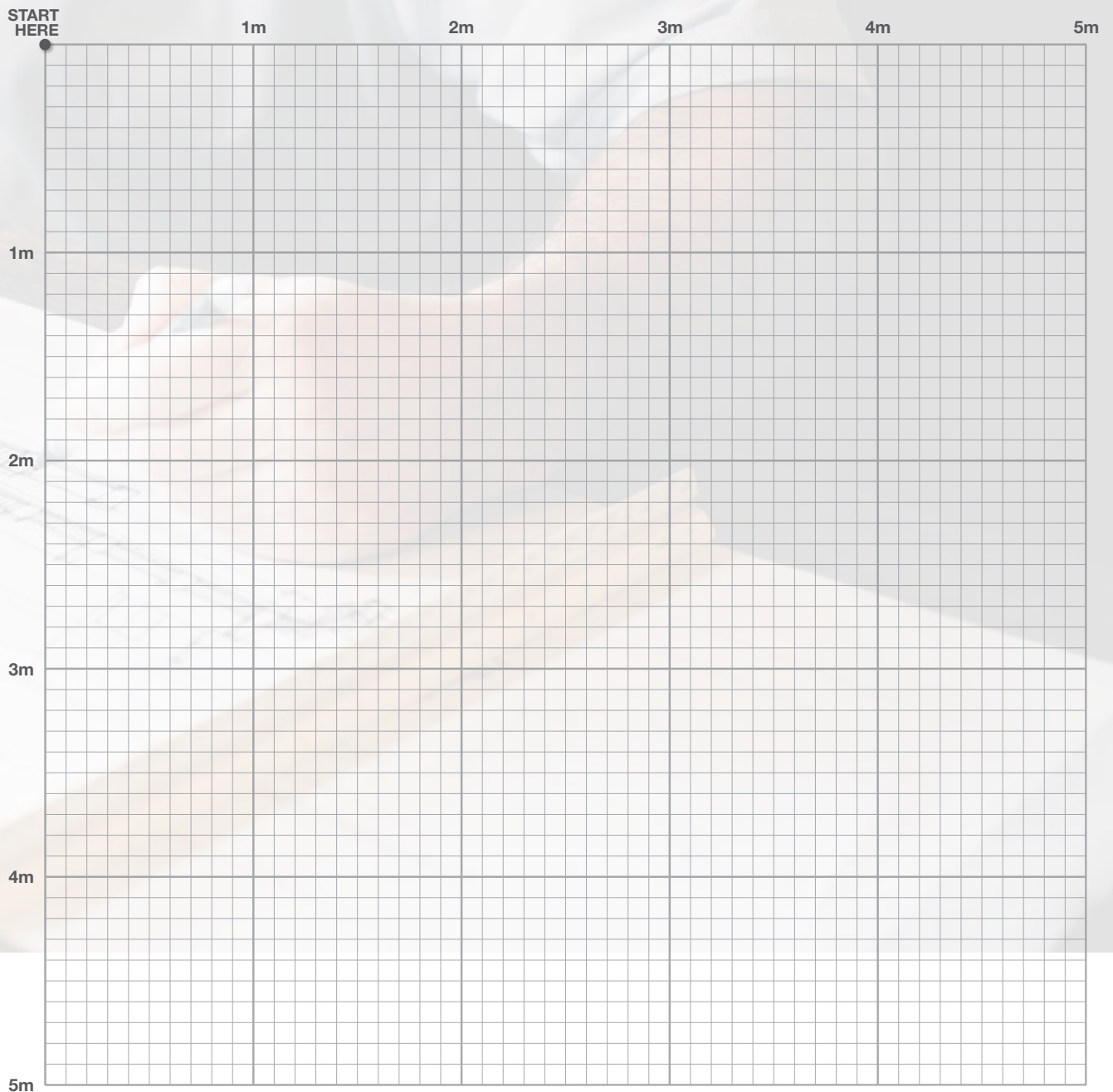

Delivery & Install

HOME DELIVERY

Your Principal kitchen is available for you to take home from your local store, flat-packed for transportation. Or we can arrange delivery to your home if you'd prefer, for an additional fee. Just ask one of our staff for more information (NB: 14 working days should be allowed for any items that need to be ordered in to complete your kitchen).



INSTALL IT YOURSELF

The Principal kitchen range is conveniently packed, making it simple for you to assemble and install. All cabinets are pre-drilled with all assembly hardware included. Alternatively, speak to our staff who will be able to refer you to a suitable local trade professional to quote for the installation of your kitchen.



Copy of the installation guide is only available on the Home Timber & Hardware and Mitre10 websites

Essentials Checklist

Every great Kitchen project needs to have all the essential components. Use this checklist to make sure you have all your bases covered before you build.

Have you marked on your plan before designing:

- Water and waste
- Doorways and windows
- Electrical outlets and existing lighting

Have you selected your finishes:

- Doors and drawer fronts p.6
- Benchtop p.46
- Splashback p.50
- Wall paint
- Flooring

Have you included these essentials in your design:

- Drawers for cutlery
- Fridge
- Pantry p.44
- Handles for your cupboards p.52
- Oven p.54
- Cooktop p.54
- Rangehood p.54
- Sink p.56
- Bin p.66

Have you selected your functional storage?:

- Pantry solutions p.60
- Overhead storage p.64
- Base storage p.62
- Drawer organisation p.65
- Corner solution p.63
- Waste & Laundry management p.66

6 Cabinet Design

To help determine which kitchen is the right match, we have developed a pricing comparison guide for you. Please see in-store for Principal kitchens pricing.

Based on a typical six cabinet straight line kitchen, the comparison guide makes it easy to compare the pricing for each of the styles.

Cabinets	Doors & Drawer Fronts	Panels	Benchtop
1 x 450mm Pantry	1 x 450mm Pantry Door	2 x Pantry End	1 x 600mm (deep) Laminate
1 x 900mm 2-Drawer	1 x 900mm 2-Drawer Pack	1 x Base End	
1 x 600mm Oven Base	1 x 450mm Door	1 x 600mm Oven Panel Pack	
1 x 450mm Base	1 x 450mm 4-Drawer Pack	2 x 2400mm Kickboard	
1 x 450mm 4-Drawer	2 x 300mm Door		
1 x 600mm 2-Door Base			

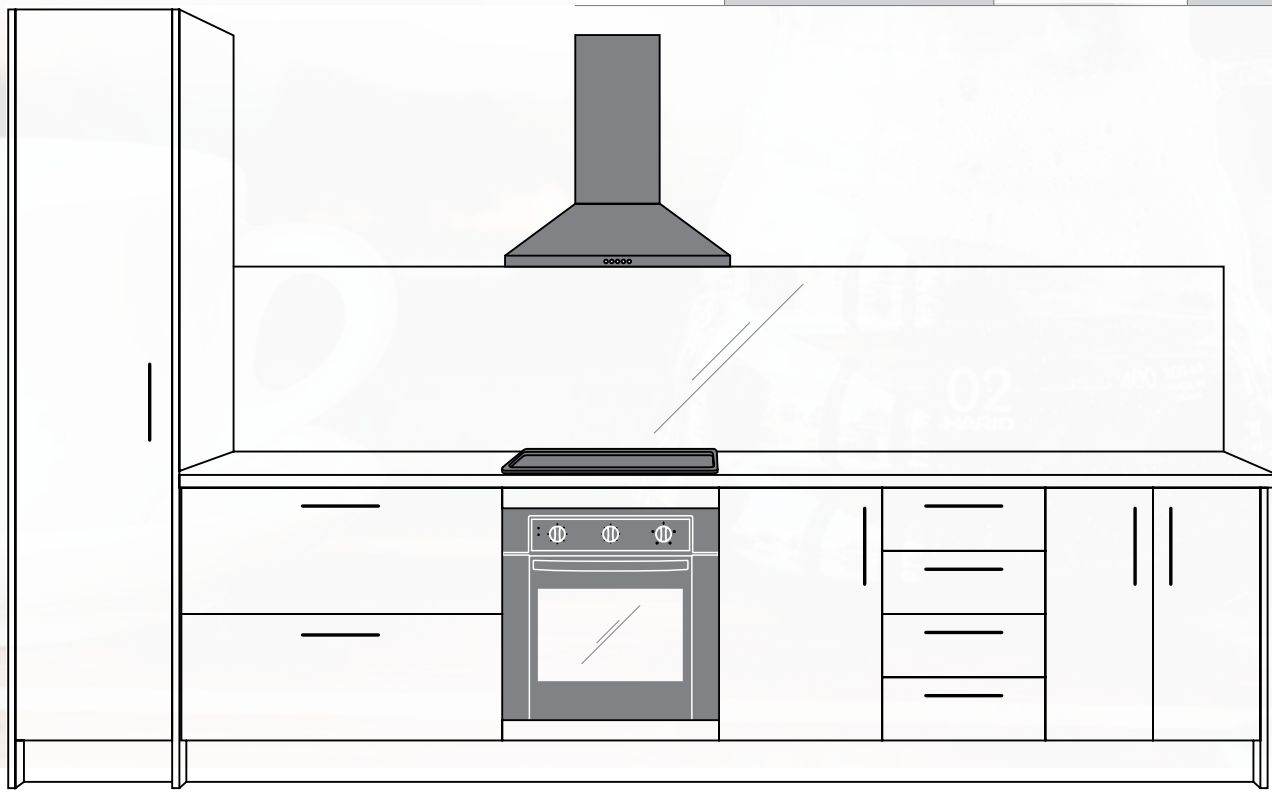

Design Plan

PANTRY 450	DRAWER 900	OVEN 600	BASE 450	DRAWER 450	BASE 600
TEP	TEP				BEP



Own your new kitchen sooner.

Zip is a simple, flexible way to get the things you need now and pay for them later, interest free.



Great for bits and bobs

Up to \$1000*



Ideal for the bigger jobs

Over \$1000**



Reusable account

Apply for a reusable account with a limit to suit you.



No upfront payments

We pay the store for you, and you take the goods the same day.



Interest free

Easy interest free payments.
No hidden fees.



Flexible repayments

Choose a repayment amount and schedule to suit you.

zip.co/apply

*Minimum monthly repayments are required. A monthly account fee of \$6.00 applies. Pay your closing balance in full each month and we'll waive the fee.

**Minimum monthly repayments are required. Paying only the minimum monthly repayment amount will not pay out the purchase within the interest free period. Any balance outstanding at the expiry of the interest free period for the purchase will be charged interest at the contractual rate, currently 19.9%. A \$6 monthly account fee applies. A one-off establishment fee may apply.

Available to approved applicants only. Terms & Conditions apply and are available on application. See your contract for further details. Credit provided by zipMoney Payments Pty Limited (ABN 58 164 440 993, Australian Credit Licence Number 441878).

Warranty Information

Warranty Against Defects

1. Our goods come with guarantees that cannot be excluded under the Australian Consumer Law. You are entitled to a replacement or refund for a major failure and for compensation for any other reasonably foreseeable loss or damage. You are also entitled to have the goods repaired or replaced if the goods fail to be of acceptable quality and the failure does not amount to a major failure. Where a failure does not amount to a major failure, the Independent Hardware Group is entitled to choose between providing you with a repair, replacement or refund. To obtain compensation, you would need to provide documentary evidence of the loss or damage suffered, and documentary evidence that such loss or damage was a reasonably foreseeable consequence of a failure by the Independent Hardware Group to comply with a consumer guarantee under the Australian Consumer Law. Such evidence may include photographs, statutory declarations, receipts or reports (eg from your doctor), depending on the loss or damage.
2. In addition to all rights and remedies to which you may be entitled under the Competition and Consumer Act 2010 and any other relevant legislation, the manufacturer warrants Principal kitchens to be free from defects in workmanship for a period of 10 years from the date of purchase.
3. In order to claim under this warranty simply visit the Independent Hardware Group store (Mitre 10, Home Timber & Hardware, Thrifty-Link or True Value Hardware), along with proof of purchase (typically this will be a receipt) and evidence of the fault (for example, a photo of the fault in the relevant product). Any cost incurred by you in bringing the product or evidence of the fault to the service desk will be borne by you. An inspection may be required. We will then arrange, at our option or at the option of the manufacturer, to either repair or replace the product, or refund your money and take back the product — in accordance with our Returns Policy, a copy of which is available in store.
4. Our liability under this manufacturer's warranty is subject to us being satisfied that a defect was caused by defective workmanship, and was not caused by or substantially contributed to by other factors or circumstances beyond our control, including (but not limited to) defective installation, maintenance or repair, alteration or modification of the product in a manner not recommended by the manufacturers or any neglect, misuse or excessive use.
5. The benefits conferred by this manufacturer's warranty are in addition to all rights and remedies conveyed by the Competition and Consumer Act 2010, and any other statutory rights to which you may already be entitled, and this warranty does not exclude, restrict or modify any such rights or remedies that are implied by law.
6. This warranty is provided by the Independent Hardware Group - Mitre 10 Australia Pty Ltd ABN 98 009 713 704. Home Timber & Hardware Group Pty Ltd ABN 64 004 037 049. 1/19 Corporate Drive, Heatherton, VIC 3202. Phone: 1300 880 440.

IMPORTANT - PLEASE READ:

All information and tips in this publication are of a general nature only and The Independent Hardware Group does not warrant the accuracy or completeness of the information and tips in this publication. This publication is not intended to be a substitute for expert advice. The Independent Hardware Group advises you to always consult an experienced and qualified person when undertaking jobs of this kind (including consulting a qualified trades person such as an electrician or plumber where relevant expert services are required). You should also consider any safety precautions that may be necessary when undertaking the work described in this publication (including wearing any necessary safety equipment such as safety glasses, goggles or ear protectors or hard hats). The information and tips in this publication are provided on the basis that The Independent Hardware Group excludes all liability for any loss or damage which is suffered or incurred (including, but not limited to, indirect and consequential loss or damage and whether or not such loss or damage could have been foreseen) for any personal injury or damage to property whatsoever resulting from the use of the information and tips in this publication. The Independent Hardware Group also notes that there may be laws, regulations or by-laws with which you must comply when undertaking the work described in this publication. You should obtain all necessary permissions and permits from council and/or any other relevant statutory body or authority before carrying out any work. Colours shown are as close as possible to actual product colours. Always confirm your choice with the sample products shown on the in-store displays. Independent Hardware Group reserves the right to correct any printing errors.

Mitre 10 Australia Pty Ltd ABN 98 009 713 704. Home Timber & Hardware Group Pty Ltd ABN 64 004 037 049

Principal.



Principal.



Available from your leading independent hardware store: